

BROCHE BLISTER DOT2

SOFADI

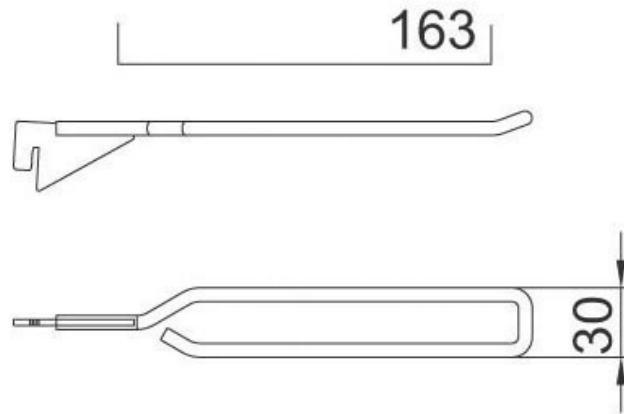

<https://www.socomenal.com/broche-blister-dot2-p30499>



Tel : 03 88 78 96 96

Fax : 02 43 30 26 16

www.socomenal.com