

EMBASE CRUCIFORME À VISSER

HETTICH

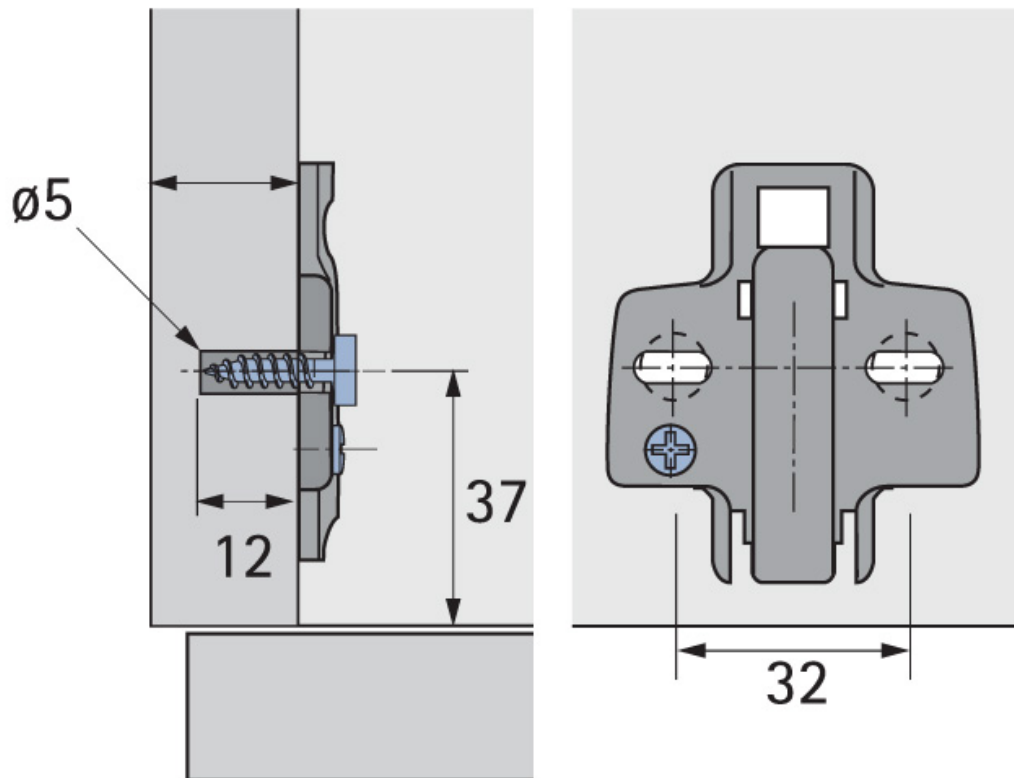

<https://www.socomenal.com/embase-cruciforme-a-visser-p23373>



Tel : 03 88 78 96 96

Fax : 02 43 30 26 16

www.socomenal.com