

# EMBASE CRUCIFORME À VISSER

HETTICH

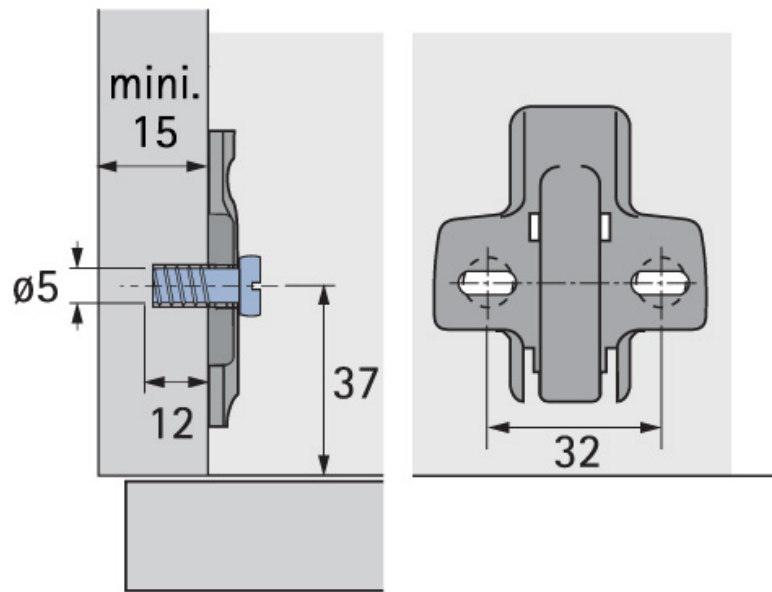

<https://www.socomenal.com/embase-cruciforme-a-visser-p23379>



Tel : 03 88 78 96 96

Fax : 02 43 30 26 16

[www.socomenal.com](http://www.socomenal.com)