

ÉQUERRE 2 TROUS

ITAR

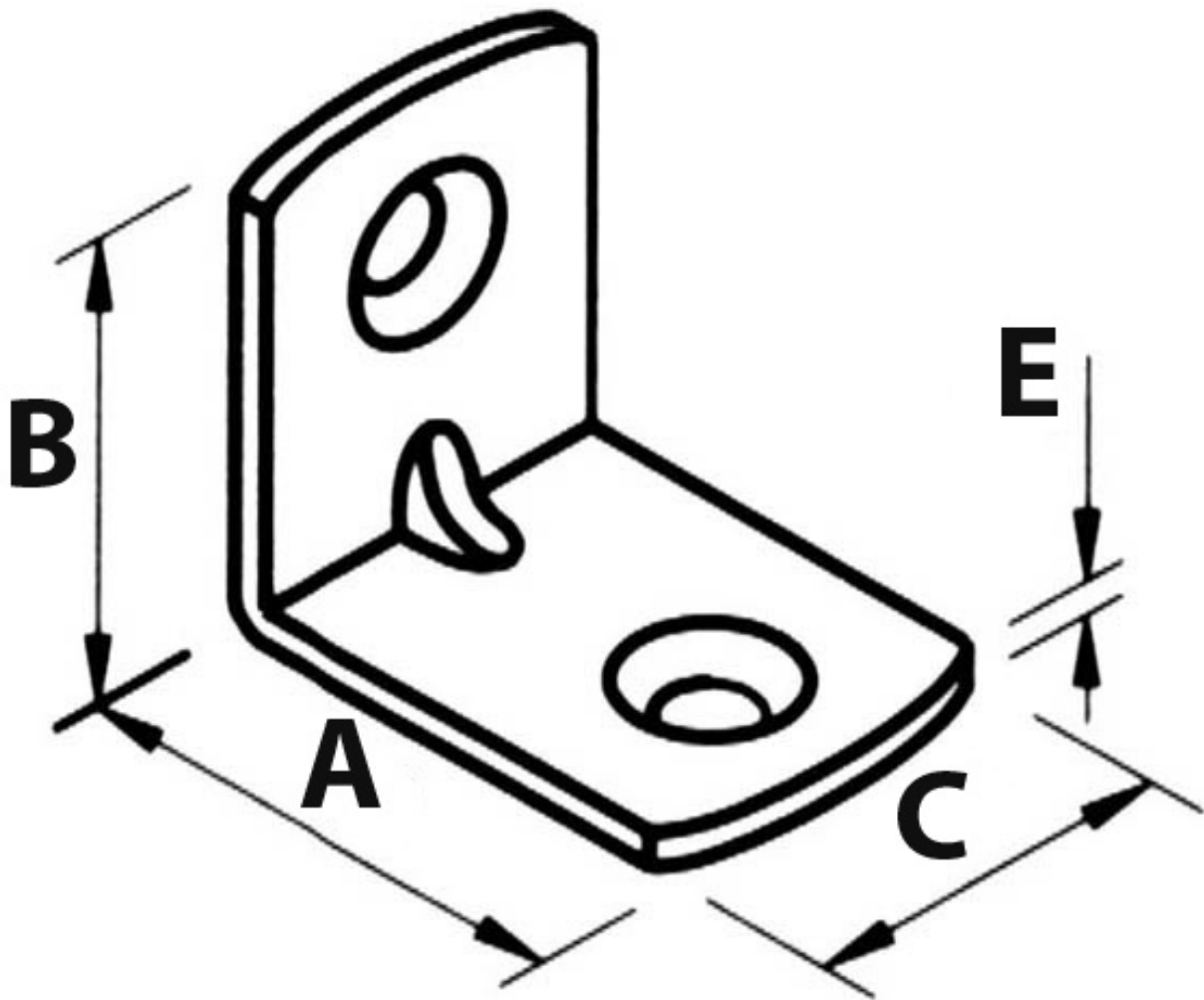

<https://www.socomenal.com/equerre-2-trous-p2446>



Tel : 03 88 78 96 96

Fax : 02 43 30 26 16

www.socomenal.com