

FERMETURE À LEVIER

ITAR

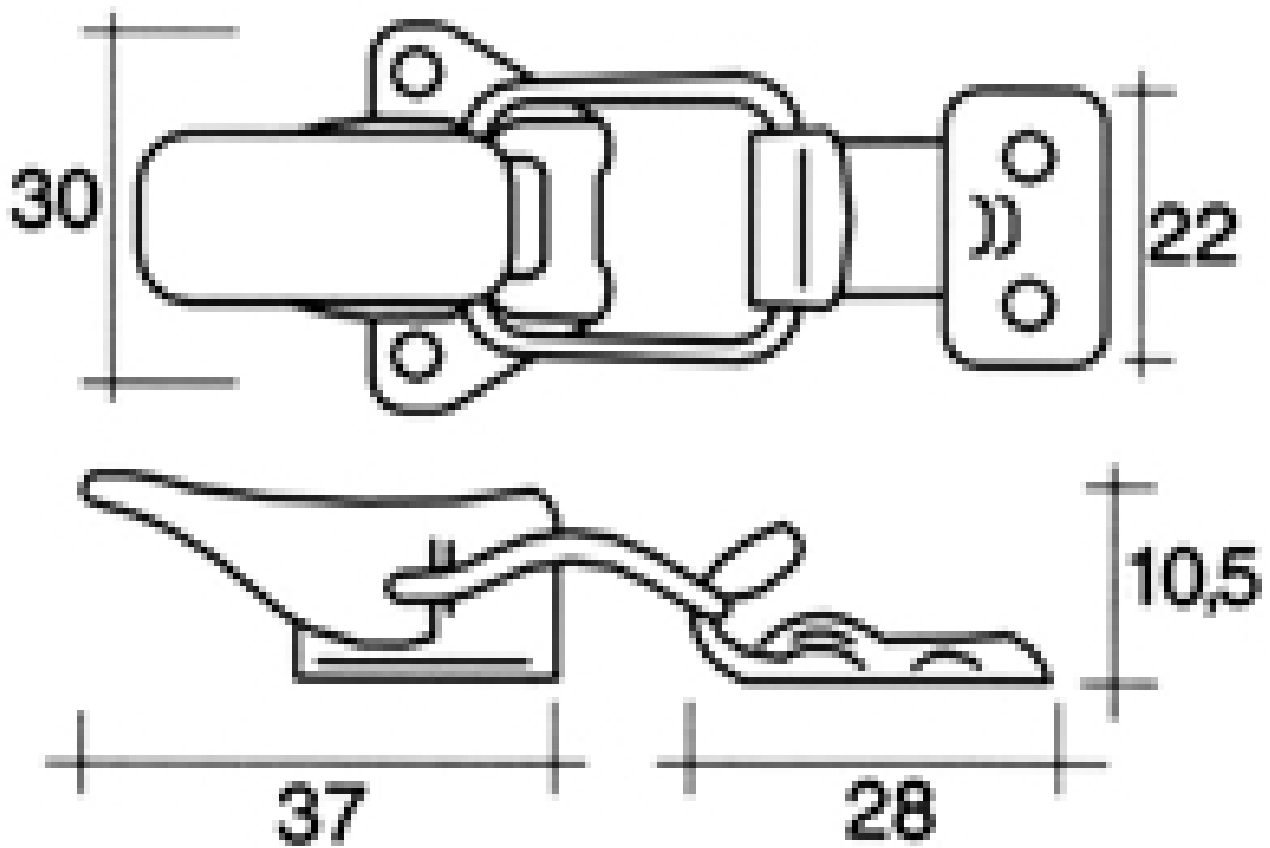

<https://www.socomenal.com/fermeture-a-levier-p2505>



Tel : 03 88 78 96 96

Fax : 02 43 30 26 16

www.socomenal.com