

# GOUJONS À VISSER DU 426

HETTICH

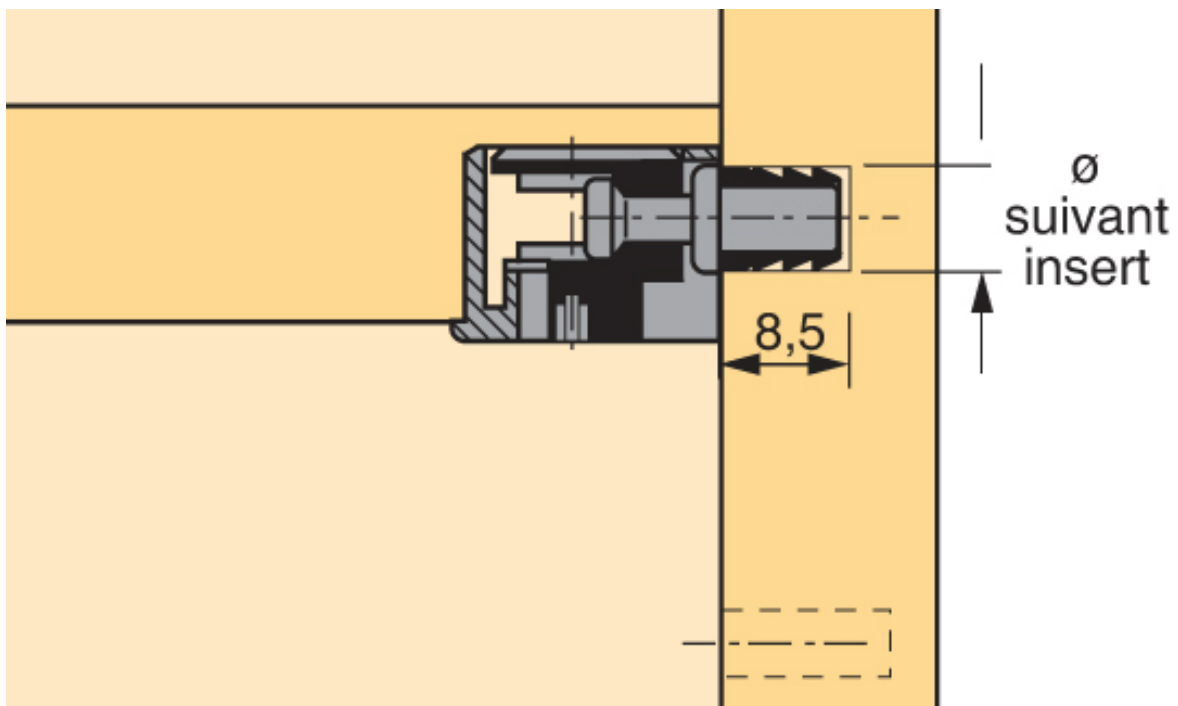

<https://www.socomenal.com/goujons-a-visser-du-426-p21687>



Tel : 03 88 78 96 96

Fax : 02 43 30 26 16

[www.socomenal.com](http://www.socomenal.com)

# GOUJONS À VISSER DU 426

HETTICH

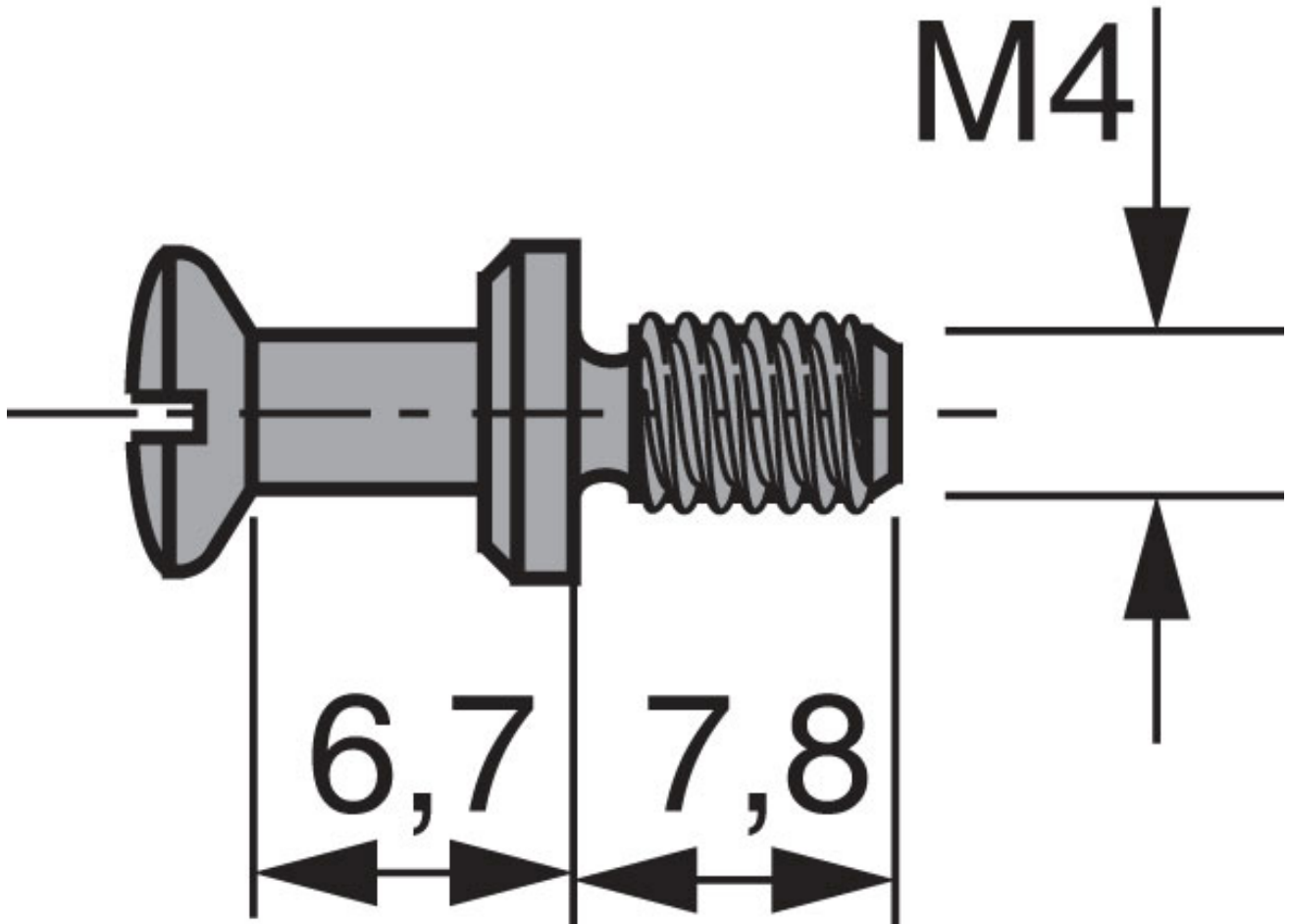

<https://www.socomenal.com/goujons-a-visser-du-426-p21687>



Tel : 03 88 78 96 96

Fax : 02 43 30 26 16

[www.socomenal.com](http://www.socomenal.com)