

KIT ARCITECH 94 AVEC BANDEAUX HAUTEUR 282

HETTICH

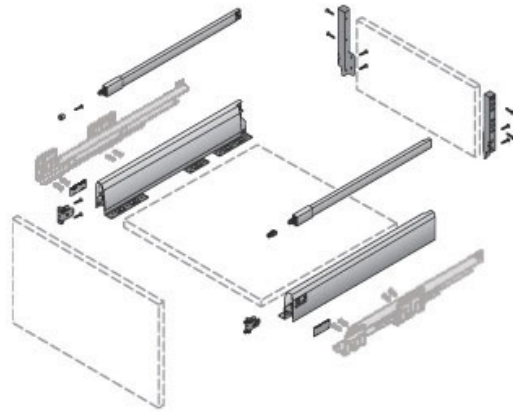

<https://www.socomenal.com/kit-arcitech-94-avec-bandeaux-hauteur-282-p31239>



Tel : 03 88 78 96 96

Fax : 02 43 30 26 16

www.socomenal.com