

# PIED ACIER Ø28 AVEC EMBASE

CAMAR

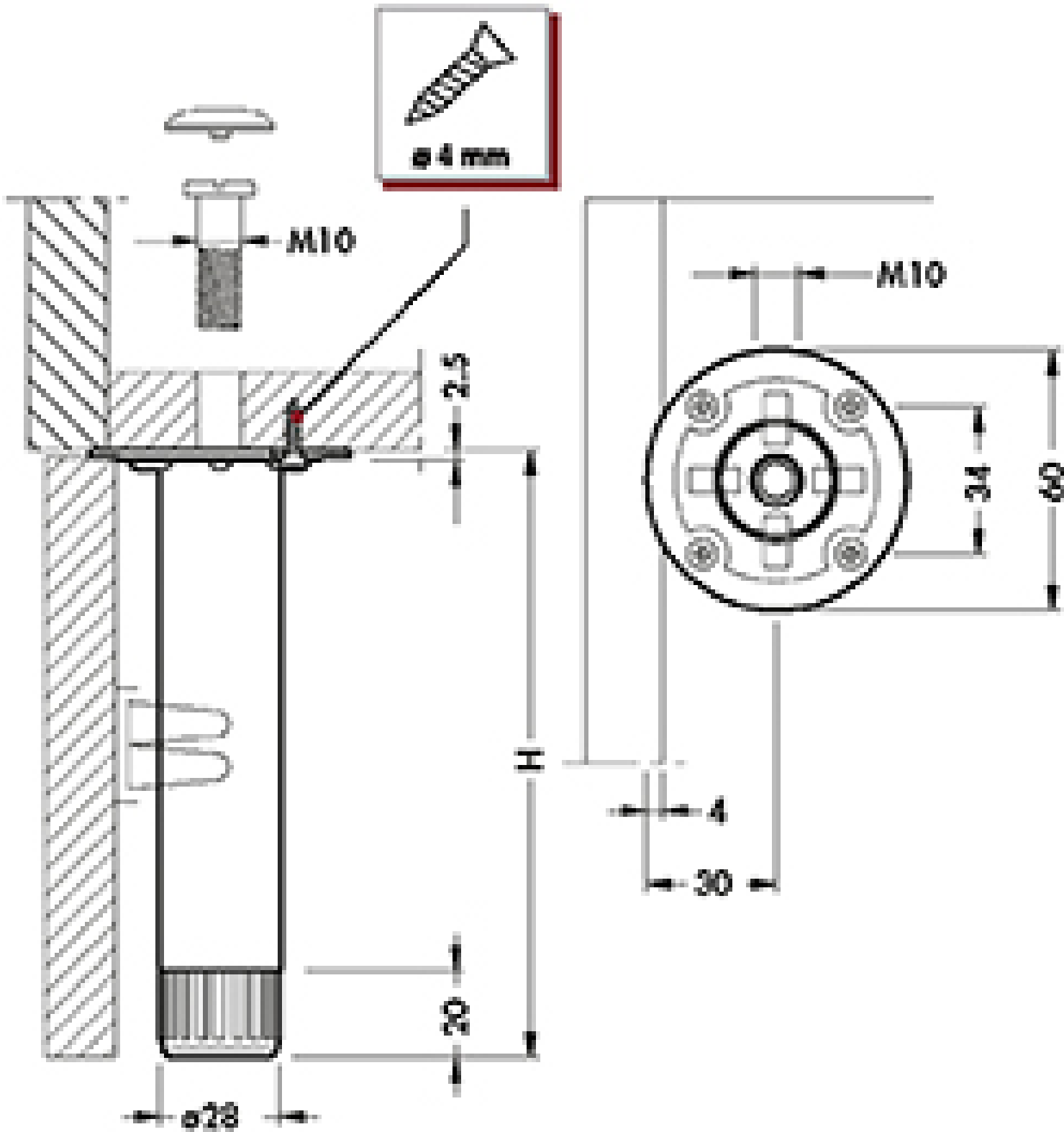

<https://www.socomenal.com/pied-acier-diam28-avec-embase-p7345>



Tel : 03 88 78 96 96

Fax : 02 43 30 26 16

[www.socomenal.com](http://www.socomenal.com)